



STAND ALONE COLD/FROZEN FOOD VENDOR

(GVC2 Controller)



MODELS:

**3576M/3576MA – MULT-ZONE
(Cold and Frozen Food)**

**3576F/3576FA – SINGLE-ZONE
(Frozen Food)**

**3576C/3576CA – SINGLE-ZONE
(Cold Food)**

SERVICE MANUAL

Table of Contents

INTRODUCTION	1	0 DIAGNOSTICS	22
SPECIFICATIONS.....	2	TEMPERATURE CONTROL	26
UNPACKING.....	3	HEALTH SAFETY FIELD TEST	28
LOADING PRODUCTS	5	REFRIGERATION.....	29
TRAY ADJUSTMENTS.....	6	REMOVING THE REFRIGERATION SYSTEM.....	34
SPIRAL ADJUSTMENT.....	8	PREVENTIVE MAINTENANCE.....	34
AUTOMATIC DELIVERY LIFT	9	CONVERTING FROM SINGLE ZONE TO MULTI-ZONE MODE	35
CONTROLLER FUNCTIONS	11	CONVERTING FROM MULTI-ZONE MODE TO SINGLE ZONE.....	35
SERVICE MODE.....	12	REPLACE AIR FILTER.....	36
BASIC PROGRAMMING SETUP ..	12	PARTS ORDERING PROCEDURE	38
4.0.7 REFRIGERATION CONFIGURATION SETTINGS	18	BEFORE CALLING FOR SERVICE	38
PRICING	20		
7 ADVANCED OPTIONS	21		
9 TEST ALL MOTORS.....	21		

Please have the model and serial numbers if you need service and parts information. The numbers are on the identification plate located on the back side of the cabinet of the vending machine.

If you have any questions pertaining to information in the manual, replacement parts or the operation of the vendor, then you should contact your local distributor or:

VendNet
8040 University Blvd
Des Moines, IA 50325
Phone: (800) 833-4411
International (515) 274-3641
Parts Fax: (515) 274-5775
Sales Fax: (515) 274-0390
E-mail: vendnet@vendnetusa.com

MODEL NUMBER: _____

SERIAL NUMBER: _____

INTRODUCTION

This manual contains instructions, service and installation guidelines for the **Stand Alone Multi-zone/Cold/Frozen Food Vendor**. Please read this manual thoroughly and follow the instructions. The initial set-up of a vendor is a very important step of insuring that the equipment operates in a trouble-free manner.

This vendor can be factory configured to have two temperature compartments (top and bottom) in a single vending machine separated by moveable air deflectors and insulating barrier. The vending machine has an air duct that runs up and down on the back inner wall of the cabinet. Each compartment can have 3 moveable trays and a total of 6 trays for the entire vending machine. The vending machine will maintain 2°C (36°F) in the Top compartment and down to -24°C (-12°F) in the bottom compartment at an ambient range of 4.4°C-32°C (40°F-90°F). The temperature setting for both compartments are set by the controller (program).

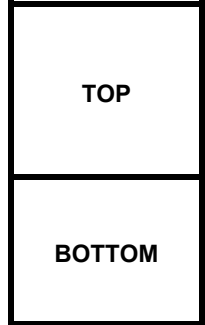

The top compartment has a heater system to maintain constant temperature across varying ambient temperatures. This consists of a heater, temperature sensor, air circulating blower and relays

The bottom compartment has a temperature sensor and an insulated refrigeration system. Cool air is drawn from the refrigeration system's evaporator coils through the air duct and is deflected into the bottom zone by a moveable air deflector. There are openings in the bottom trays to allow air to circulate around the products.

All programming of the pricing, vend functions and features are also done at the controller. Changes can be made without any additional accessories or remote parts. Selections can be priced individually from \$00.00 to \$655.35 in five cent increments (US currency). Cash accountability records, total cash transactions, total vend cycles performed by the vendor, information for individual selections, complete rows or total machine can be compiled and used for inventory and ordering records. Electrical malfunctions are recorded and displayed when the vending machine is placed in the **Service Mode**. Non-functional motors or selections are indicated. Each selection has an individual motor. Functional selections will continue to operate if other motors become nonfunctional.

The vending sequence is "first-in, first-out" for each selection, permitting stock rotation to maintain fresh products in the vending area.

Each variant has the capability of supporting a "satellite" vending machine, such as a direct wire CB300-SAT, or a USD satellite food such as a MZF Model 3530. The satellite vendor utilizes the vendors existing controller, coin mechanism, bill validator and keypad to perform the vend functions they require. The model 3530 has on-board refrigeration and motor controls. For details on the satellite vendor, refer to the Service Manual pertaining to the specific vendor for installation instructions.

SPECIFICATIONS

DIMENSIONS & WEIGHT

TYPE	MULTI-ZONE (3 WIDE)	
MODEL	3576	3576A
WIDTH	29.5 in. (74.9 cm)	
DEPTH	38 in. (96.5 cm)	
HEIGHT	72 in. (182.9 cm)	
ESTIMATED WEIGHT¹	693 lbs (614 kg)	

Note: ¹Weights will vary depending on optional equipment installed.

ELECTRICAL

MODEL	EMBRACO	
VOLTAGE	115 VAC	230 VAC
CYCLE	60 Hz	50 Hz
NOMINAL AMPS	9.0 Amps	4.5 Amps
TRANSFORMER	110/24 VAC	230/24 VAC

REFRIGERATION

HORSEPOWER	EMBRACO
TYPE	Hermetically Sealed
CONTROLS	Electronic
REFRIGERANT	R-404a
CHARGE	17 oz (482g)

COIN CHANGER, BILL VALIDATOR, CARD READER

TYPE	MDB Coin Changer level II or III, Bill Validator Level I, Card Reader Level I or II
-------------	---

VENDOR OPERATION

LOCATION	Suitable for indoor use only. This appliance is not suitable for installation in an area where a water jet could be used.
RECOMMENDED OPERATING TEMPERATURE	Between 40° and 100° Fahrenheit (4° and 38° Celsius)

UNPACKING

This vending machine was thoroughly inspected before leaving the factory and the delivering carrier has accepted this vendor as their responsibility. Note any damage or irregularities at the time of delivery and report them to the carrier. Request a written inspection report from the claims inspector to file any claim for damage. File the claim with the carrier (not the manufacturer) within 15 days after receipt of the vending machine.

Carefully remove the outside packing material so as not to damage the finish or exterior of the vending machine. Inspect the vending machine for concealed shipping damage. Report any damage hidden by the shipping material directly to the delivering carrier on a hidden damage report.

Record the model number and serial number of the vendor for your records. These numbers can be found on the Serial Plate on the rear of the cabinet and/or inside the vendor. Refer to these numbers on all correspondence and inquiries pertaining to this vendor.

Remove the shipping skids by supporting the vendor from below, inserting a large screwdriver or prying tool into the groove and splitting it in two. After removing the pieces, turn the leveling screws in as far as possible. (See Figure 1).

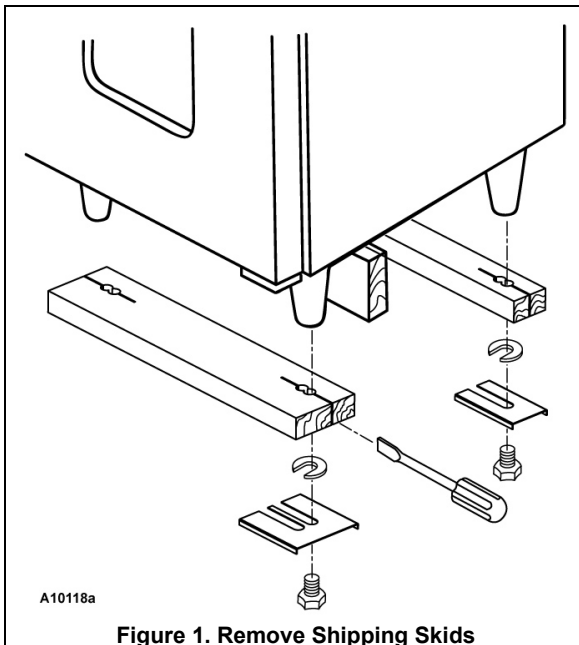

INSTALLATION

- This vendor should only be installed where it can be overseen by trained personnel.
- The maximum safe tilt angle of this vendor is 10°.
- Do not attempt to move the vendor by hand; it should only be moved using equipment with the proper load rating.
- Consult local, state and federal codes and regulations before installing the vendor.
- Retrieve the keys to the vendor from the coin return cup.
- Open outer door and remove all internal packing material.

Position and level vendor prior to connecting vendor to power. All set up must be completed prior to prevent harm to the installer or vendor.

POWER CORD INSTALLATION

The power cord is a 14 gauge cord and is fastened to rear mounting box so it stays with the machine and doesn't get changed with a lighter gauge cord. The power cord is connected and routed under the cover as shown in Figure 2. Keep power cord secured on the center back of the cabinet until the vendor is placed into its final location to prevent damage to the cord.

Position the vendor in its place of operation no further than nine feet from the power outlet or receptacle. Check that the door will open fully without interference. Leave at least four (6") inches of space between the back of the vending machine and any wall or obstruction for proper air circulation.

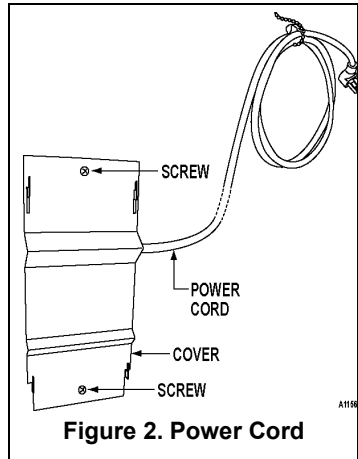

Figure 2. Power Cord

LEVEL THE VENDOR

All levelers must touch the floor. The vendor **must** be level for proper operation, cabinet to door alignment, condensate drainage, and for acceptance of coins through the coin mechanism.

GROUNDING (EARTHING) & ELECTRICAL

Before connecting the vendor, the integrity of the main electrical supply must be checked for correct polarity, presence of ground (earth) and correct voltage. Please refer to the **Safety Manual and Installation Guidelines Manual** (P/N 4206816) that shipped in the service package with your vending machine. These checks should be repeated at six (6) month intervals with the routine safety electrical testing of the vendor itself.

If the receptacle is not properly grounded or polarized, you should contact a licensed electrician to correctly polarize and/or ground the receptacle to ensure safe operation.

For proper operation of any equipment utilizing electronically controlled components, the equipment should be placed on an isolated or dedicated noise-free circuit, properly polarized and grounded.

MAIN POWER SWITCH

Plug the power cord to a dedicated power outlet. Open the vendor door. Turn on the main power switch located on the center right hand side of the vendor. See Figure 3.

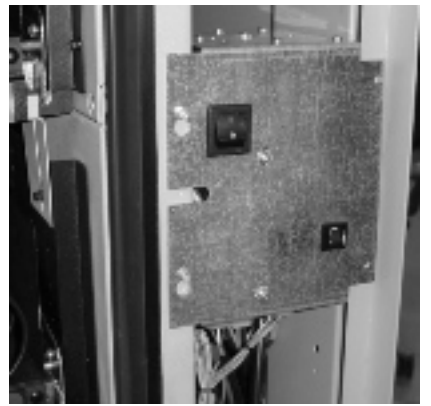

Figure 3. Power Panel

LOADING PRODUCTS

Load product from front to back making sure all items fit freely between the auger spaces. Do not attempt to force oversize items or packages into the spaces. Do not skip a space. Place the product on the bottom of the compartment on the product augers with the label facing the front of the vending machine for easy identification by the customer. See Figure .

SNACK/CANDY/FOOD TRAY OPTION

To load products, lift the tray slightly and pull forward until the tray stops. The trays tilt for easier loading.

The size of the item being vended must be larger than the diameter of the auger being used to vend properly.

Undersize items could cause vend problems. If the product does not fit the auger properly, use a different pitched auger (see Figure 4). Augers available from your distributor or service entity.

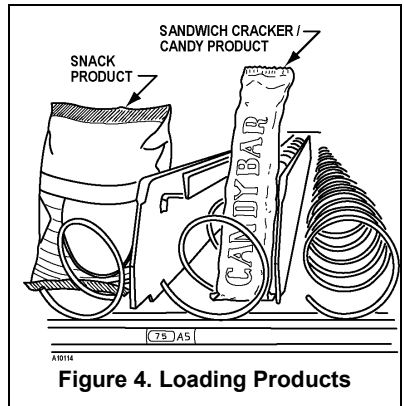

Figure 4. Loading Products

PRODUCT				PART NUMBER
TYPE	WIDTH (INCH)	THICK (INCH)	QTY	
CANDY	2.75	0.50	30	4200272.103309
		0.66	24	4200272.102309
		0.94	18	4200272.101309
		1.19	15	4200272.100309
		1.50	12	4200272.104309
		2.03	9	4200272.105309
		3.09	6	4200272.106309
CAN/BOTTLE	2.75	3.09	6	4200272.106309
DISPENSER (12 OZ CAN)	4.84	2.59 DIA	8	4214090
SNACK	5.50	1.19	15	4200272.109309
		1.50	12	4200272.108309
		1.81	10	4200272.107309
		2.62	8	4200272.111309
		2.69	7	4200272.110309

TRAY ADJUSTMENTS

By re-timing the augers, difficult-to-vend items can be dispensed more dependably. By altering tray spacing, larger items can be vended. By changing the tray configuration, different product mixes can be accommodated.

VERTICAL SPACING

The trays can be adjusted up or down in half-inch increments to provide additional headroom for vending taller products. When increasing the height in one area, the same amount of room will be lost at the tray above or below the one being adjusted.

3 WIDE SNACK/CANDY/FOOD TRAY

1. Pull out the tray to be adjusted until it stops.
2. Disengage the tray harness from its harness retainer on the right side wall. See Figure 5a on page 7. Disconnect the tray plug from its receptacle on the right side wall.
3. Lift up on the rear of the tray and remove it from the vendor.
4. Disengage both left and right tray rails from their corresponding slots on the left and right side walls by removing two screws holding each rail in place.
5. Relocate both left and right rails by reversing step 4. **Rails must be level from front to back and evenly spaced from top to bottom of each side.**
6. Replace the tray by placing its rear rollers on the left and right rails and lifting up on the front of the tray as it is pressed back.
7. Install the tray plug into its receptacle on right side wall.
8. Re-engage the tray harness into its harness retainer. See Figure 5a
9. Test vend the tray in its new position to assure that the tray plug is properly seated.

3 WIDE SNACK/CANDY/FOOD TRAY

1. Pull the tray out until it stops.
2. Locate the harness retainer on the right sidewall. See Figure 5a. Pull the tray harness out of the harness retainer.
3. Unplug the tray plug from its receptacle on the right side wall.
4. Lift up on the front of the tray and pull slightly (approximately 1.5 cm (.5 in) forward to clear the tray stop.

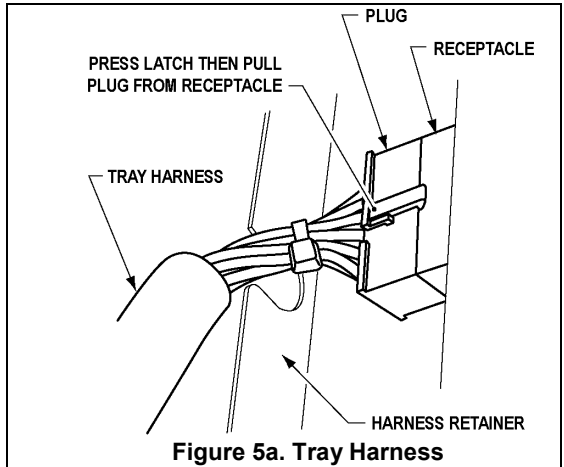

Figure 5a. Tray Harness

5. Locate the release lever on the left and right tray rails. See Figure 5b. Swing the release levers all the way up to unlatch.
6. Lift up on the rear of the tray and remove it from the vendor.

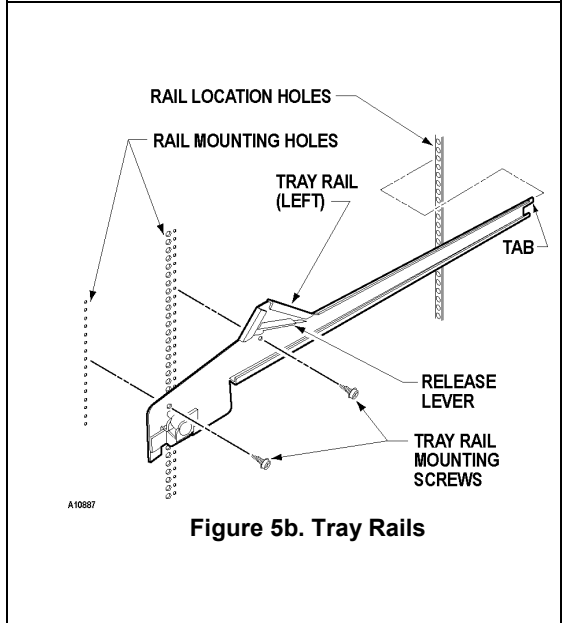

Figure 5b. Tray Rails

7. Relocate both left and right tray rails from the left and right side walls.
8. Remove tray rail mounting screws.
9. Pull each rail forward to disengage its rear tab from the hole in the rear wall. See Figure 5b.
10. Relocate both left and right rails by reversing step 7. **Rails must be level front to back and left to right.**
11. Replace the tray by placing its rear rollers on the left and right rails and lifting up on the front of the tray as you push it back
12. Swing the tray rail release levers all the way down.

13. Install the tray plug into its receptacle on the right side wall.
14. Re-engage the tray harness into its harness retainer.
15. Test vend the tray in its new position to assure that the tray plug is properly seated.

SPIRAL ADJUSTMENT

SNACK/CANDY/FOOD TRAY

Each auger can be rotated in 20° (degree) increments for a different product vend drop-off point. Most items can be vended successfully when the auger end is positioned at 6 o'clock.

The general rule is - **the narrower the product, then the higher the timing.**

- Thick Products - 4-6 o'clock
- Most products – 6 o'clock
- Thin Products - 6-8 o'clock

TO CHANGE AUGER TIMING

1. Remove the motor cover. See Figure 5f.
2. Raise the motor slightly and pull forward on the auger until it separates from the motor.
3. Rotate the auger to the desired position and re-insert the hub (auger coupling) into the motor. The hub (auger coupling) must be seated over the vertical rail or retaining rib on the tray.
4. Replace the motor cover making sure it is securely tightened.
5. Test vend to make sure product vends correctly.

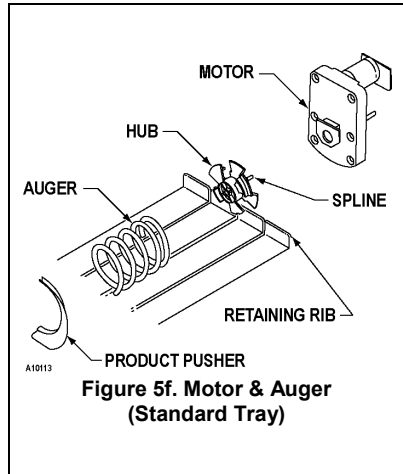

Loading Coin Mechanism

The Coin Mechanism must be loaded with some level of each coin in order for the vendor to operate properly. The coins need to be loaded into the coin mechanism by insertion into the front coin insert. First enter the SERVICE MODE then TUBE FILL MODE (See SERVICE MODE instructions – COIN/TUBE FILL MODE

Each tube should be kept loaded with at least one roll of each coin to keep above the tube low level sensors. Once the tubes are loaded

to these levels the Dollar Bill Validator will accept bills. If the coin tubes fall below this level the Dollar Bill Validator may stop accepting bills and the front display will indicate "EXACT CHANGE ONLY".

Alternatively, you can load the coins into the slots above the respective coin tubes, making sure to load the correct coins into their correct tubes. This is not the preferred method. By using TUBE FILL mode the control board can then accurately determine coin levels.

On some Coin Mechanisms there are buttons above each tube to dispense the coins (may vary depending on which coin mechanism that is used). The coins can also be dispensed within the Service Mode described later.

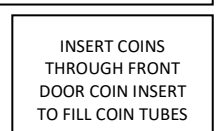
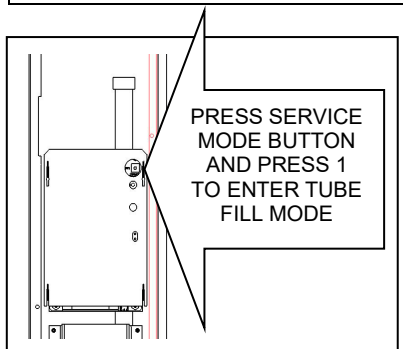

AUTOMATIC DELIVERY LIFT

This information is for machines with the GVC2 Control Board (part number 4214682.004) and software version V3.3.10177 and higher.

INTRODUCTION

The Automatic Delivery Lift system is designed to lift vended products to the 2012 American Disabilities Act (ADA) height requirement level from the locations floor. This same system can also provide an enhanced customer experience for those locations where an almost hands free vended product presentation is desirable.

The Delivery Lift system is an option that can be used on the line of Delivery Lift Ready Machines (also called ADA ready machines) and consists of an LED illuminated product delivery box with a motorized product lift plate, a set of product height sensors, a motorized delivery box door (Auto Door) and a Blue LED illuminated activation button.

The delivery lift system can be factory installed or provided as a retrofit kit for field ADA ready machines. See the list of ADA ready model numbers or contact a sales or service representative for more information.

INITIAL SETUP – SERVICE MODE

When an Automatic Delivery Lift system is installed in an ADA ready machine, it is automatically detected when a controller Service Mode Motor Count is done. The Motor Count will show the tray motor count briefly with the 3 additional delivery lift motors before returning to a tray motor count only. Once a Delivery Lift system is detected, it will complete a functional test at every Motor Count or at machine power on. When the Delivery Lift is moving, the Blue Delivery Lift Button on the front of the machine will flash and can be pressed to stop the Delivery Lift operation if necessary. Information on Service Mode Configuration menu and Diagnostic Mode menu options are listed on the following pages.

SALES MODE

When a product is selected and vended, the product drops into the Delivery Lift Box after it first passes by the iVend sensor to confirm that a product has been vended. Next, when the machine is using the default BUTTON configuration mode, the Blue Delivery Lift Button will be constantly illuminated for 10 seconds, during this period the Delivery Lift can be activated. When the illuminated button is pressed, the Delivery Door will open, the Delivery Lift will begin raising the vended product and the button will flash. The product will be raised until a portion of the product package blocks the Delivery Lift sensors, indicating that the product has reached the ADA delivery height. The machine display will now show “Please Remove Your Product” and an audible beep will occur every 10 seconds until the product is removed or one minute has elapsed. After one minute, the Delivery Door will close and the “Please Remove Your Product” message will continue to be displayed. Once the product is removed and the Delivery Lift Sensors are no longer blocked, the Delivery Lift will return to the bottom of the Delivery Box and machine display will return to the sales mode message and is ready for the next vend.

NOTE: If a customer grabs the product while the Delivery Lift is in operation, the Delivery Lift Sensors may detect a sensor blockage and will stop the Delivery Lift at its current location. Pressing the flashing Blue Delivery Lift Button will also stop the Delivery Lift.

SERVICE MODE PROGRAMMING & TEST FUNCTIONS

Once in the service mode the control functions can be accessed and used, these are the service menus specific to the Automatic Delivery Lift functions.

- **Service Mode 2 – Motor Count**

Motor count includes tray motors, changer escrow motor, delivery lift and auto door motors briefly (example – shows 40 and then goes back to 36d) to show the additional motors and then returns to show only tray count.

- **Service Mode 4 – Configuration**

The Delivery Lift feature can be set to:

1. Button Mode- The Delivery Lift Button will need to be pressed to activate the Lift.
2. Automatic Mode – The lift will run after each vend.
3. OFF

- **Service Mode 0 – Diagnostics**

Contains functions for testing the Automatic Deliver Lift Door, Delivery Lift and Delivery Lift Sensors.

See the Basic Programming pages starting on page 15 for additional information on the Automatic Delivery Lift service modes.

CONTROLLER FUNCTIONS

IVEND® CYCLE

All vendor selections have been assigned at the factory to be monitored for iVend™ optical sensing.

For 5 milliseconds at the start of a vend, the iVend® optical sensor will be checked to make sure it is not blocked, damaged or disconnected.

If blocked, damaged or disconnected - the normal home-switch-vend cycle will be used and the optical sensors will be ignored. Both the vend motor and a vend timeout timer are started.

- The selection motor rotates to the home-switch position.
- If there is a home-switch signal, then the vend is considered successful.
- If after 10 seconds there is no home-switch signal, the vend failed. The vend motor is shut down and **MAKE ALTERNATE SELECTION** is displayed. The customer can press selection buttons to activate another motor or press the coin return button.

If not blocked, damaged or disconnected - the iVend® Sensor System is used.

The vend motor and a vend timeout timer are started.

- The selection motor rotates to the home-switch position.
- If a product is detected during this time period, then the vend is considered successful.
- If after reaching the home-switch position and a product is not detected, then the vend motor will pause for 1 second while the controller continues to monitor the optical sensor for product delivery.
 - If a product is detected during this pause, then the vend is considered successful.
 - If a product is not detected, then the controller initiates a second vend cycle and another vend timeout timer while continuing to monitor the optical sensor.
 - ✓ If a product is detected during this second cycle, the motor will be stopped immediately. The vend is considered successful. The **2ND VEND** accounting counter is increased by one.
 - ✓ If after reaching the home-switch position and a product is not detected, then the vend motor is stopped and for 2 seconds the controller continues to monitor the optical sensor for product delivery. If a product is detected, the vend is considered successful. The **2ND VEND** accounting counter is increased by one.
 - ✓ Otherwise, if no product is detected, the selection is sold out. Such a state will trigger the display of the **MAKE ALTERNATE SELECTION** message. The amount of credit is displayed. The customer can press selection buttons to activate this or another motor or press the coin return button.
 - If after 10 seconds there is no home-switch signal and no product is detected, then the vend failed. The vend motor is shut down and **MAKE ALTERNATE SELECTION** is displayed. The customer can press selection buttons to activate another motor or press the coin return button.

NOTE: Force Vend is disabled to permit customer to retrieve deposited money.

SERVICE MODE

Use **Service Mode** to program and service the machine. Use the keypad as an input device. Watch the display for information while in Service Mode.

SERVICE MODE BUTTON

To enter **Service Mode**, press the **Service Mode Button** located on the top or upper right corner of the controller cover. See. To exit Service Mode, press the Service Mode Button.

NOTES

If credit exists when **Service Mode** is entered, it will be restored when the machine returns to **Sales Mode**.

If no key is pressed for approximately 1 minute while in **Service Mode**, the controller will automatically return to **Sales Mode**.

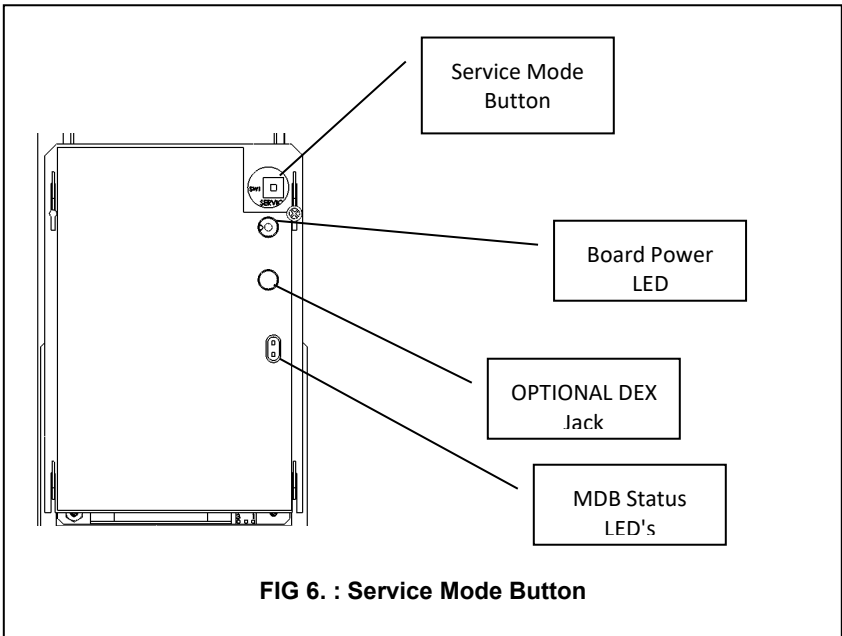

BASIC PROGRAMMING SETUP

KEYPAD

Use the buttons on the keypad as directed in the step-by-step instructions in this manual in programming the vendor.

DISPLAY

Check the display Figure 7: Keypad **Service Mode Button** and/or **Keypad Buttons** to make sure that the program is responding correctly.

Buttons 0-9 are used to move between the various modes, menus and sub-menus; while the **#** button is used to enter a menu, confirm or save a setting. See Figure 7

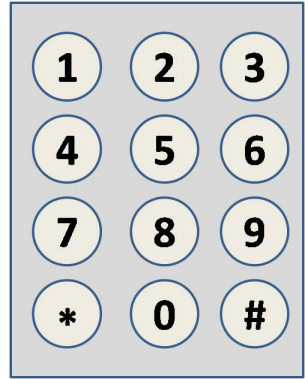

1 TUBE FILL/ DISPENSE COINS

Tube Fill counts coins as they are deposited and Shows the dollar amount.

TUBE FILL

STEP		DISPLAY
1.	Press Service Mode Button	Motor Count 60
2.	Press 1 and begin depositing coins	At least 15 of each denomination
3.	Press * 2 times to exit	(Sales Mode)

TUBE DISPENSE

Tube Dispense Pays out coins from the coin mech coin tubes.

This mode will also display the current quantity of coins in the coin mech tubes.

1.	Press 1 to dispense dollar coin or highest denomination	\$1.00/coins
2.	Press 2 to dispense quarters or next highest denomination	0.25/coins
3.	Press 3 to dispense dimes or next highest denomination	0.10/coins
4.	Press 4 to dispense nickels or next highest denomination	0.05/coins
5.	Press * 2 times to exit	(Sales Mode)

****Note:** For dispensing more than a 4 denomination coin mech. use keys greater in the same sequence as shown above.**

2 MOTOR COUNT

Displays the total count of working motors.	STEP		DISPLAY
	1.	Press Service Mode Button	Motors (- -)
	2.	Press 2 then wait.	Motors (- -)
	3.	Press * to exit.	(Sales Mode)

****Note:** Actuating a motor count sends all motors to their home positions. If product is loaded in selections when this occurs, they may be dispensed.

3 OPTIONS

3.1 FORCE VEND

See GVC2 Programming Manual (P/N 4215507) for more information.

3.2 BILL ESCROW

See GVC2 Programming Manual (P/N 4215507) for more information.

3.3 MULTI VEND

See GVC2 Programming Manual (P/N 4215507) for more information.

3.4 FREE VEND

See GVC2 Programming Manual (P/N 4215507) for more information.

3.5 FAST CHANGE

See GVC2 Programming Manual (P/N 4215507) for more information.

3.6 OPTICAL VEND

See GVC2 Programming Manual (P/N 4215507) for more information.

3.7 POINT OF SALE MESSAGE (POS)

See GVC2 Programming Manual (P/N 4215507) for more information.

3.8 SETPOINT

The following are the factory default SET POINT temperature settings for each machine type:

MACHINE TYPE	TEMPERATURE SETTINGS
<ul style="list-style-type: none">• Frozen• Slackened• Cold• Chilled• Snack• Dual Zone• Dual Upper -6	<u>NOT USED</u>
Multi-Zone Food (MZF)	<ul style="list-style-type: none">• Bottom Zone -10F (-23C)• Top Zone 36F (2C)
Multi-Zone Food-2 (MZF-2)	<ul style="list-style-type: none">• Bottom Zone -12F (-24C)• Top Zone 36F (2C)
Multi-Zone Food-5 (MZF-5)	<ul style="list-style-type: none">• Bottom Zone-15F (-26C)• Top Zone 36F (2C)
Single-Zone Frozen (SZ FROZEN)	<ul style="list-style-type: none">• -10F (-23C)
Single-Zone Frozen (SZ FROZEN-2)	<ul style="list-style-type: none">• -12F (-24C)
Single-Zone Frozen (SZ FROZEN-5)	<ul style="list-style-type: none">• -15F (-26C)
Single-Zone Cold (SZ COLD)	<ul style="list-style-type: none">• 36F (2.2C)
Single-Zone Cold (SZ COLD-1)	<ul style="list-style-type: none">• 35F (1.6C)

These temperatures should not be adjusted, and it is **not** recommended. The temperatures have been set according to NAMA specifications for optimal product safety. **Before making any adjustment see Health Safety section.**

3.9 KEYPAD BACKLIGHT

This menu controls the brightness level of the keypad backlight. (Default is 3)

STEP		DISPLAY
1.	Press Service Mode Button 	Motors (- -)
2.	Press 3	Options
3.	Press 9 to view setting.	KB Backlight
4.	Press 9 repeatedly to change setting. <i>Note:0=Off, 1=Low, 2=Med, 3 =High, 4=Max</i>	KB Backlight 3
5.	Press # to save	KB Backlight 3
6.	Press * 3 times to exit.	(Sales Mode)

4 CONFIGURATION

4.1, 4.2, 4.3: CONFIGURE MACHINE TO SNACK, CAN, OR BOTTLE

See GVC2 Programming Manual (P/N 4215507) for more information.

4.4 LANGUAGE

See GVC2 Programming Manual (P/N 4215507) for more information.

4.5 AUTO REINSTATE

See GVC2 Programming Manual (P/N 4215507) for more information.

4.6 SPACE TO SALES (STS)

See GVC2 Programming Manual (P/N 4215507) for more information.

4.7 CUSTOM STS

See GVC2 Programming Manual (P/N 4215507) for more information.

4.8 TIME/DATE

Sets the time and date for timed operations.

The following submenus are available:

Date; Time

4.8.1 DATE

STEP		DISPLAY
1.	Press Service Mode Button 	Motors (- -)
2.	Press 4	Configuration
3.	Press 8	Time/ Date menu
4.	Press 1	MM/DD/YYYY
5.	Press # to edit date	06/01/2007
6.	Press # to save.	06/01/2007
7.	Press * 4 times to exit	Sales Mode

4.8.2 TIME

Time Setting - This menu controls and displays the current time of day. The display will show a 24 hour format.







Examples:

8:05 a.m. = TIME 08.05

01:15 p.m. = TIME 13.15

11:45 p.m. = TIME 23.45

TIME SETTING

	STEP	DISPLAY
1.	Press Service Mode Button 	Motors (- -)
2.	Press 	Configuration
3.	Press 	Date/ Time
4.	Press  for Time menu	08:00:25
5.	Press  to edit	09:00:25
6.	Press  to save	09:00:25
7.	Press  4 times to exit	Sales Mode

4.9 HEALTH SAFETY (HS)

THE HEALTH SAFETY FEATURE CAN NOW BE CONFIGURED FOR 2 TEMPERATURE ZONES. A LOWER ZONE AND AN UPPER ZONE AS DETAILED IN THE HEALTH SAFETY MENUS BELOW.

The **HEALTH SAFETY** feature prevents the sale of perishable food if the air temperature inside the Food Vendor compartment rises above the Health Safety temperature limit for more than 15 minutes. The perishable products being vended must match the refrigeration configuration.















Warning: These settings require specific refrigeration systems and options in a machine. Please review this document and consult the machine service manual and if necessary, Vendnet Service at 1-800-833-4411 before making any changes to the machine settings. Please have machine model number and serial number information when calling Vendnet Service,

HEALTH SAFETY MENUS - This menu allows the user to specify the operating zone to meet health safety requirements for cold and frozen food. The health safety requirements can also be applied to an individual Item(s), Row(s), or ALL (whole machine). If the health safety requirements are violated then the Item(s), Row(s) or the whole machine is shut down accordingly.

HEALTH SAFETY ZONES - Health Safety settings are split into two zones, Upper Zone and Lower Zone. Only the Lower Zone setting will be used when the machine is configured as a Cold, Cold Food, Single Zone (SZ), Dual Zone (DZ), Single Zone Frozen (SZF) or Single Zone Cold Food (SCF). The Upper Zone setting is used is for the Multi-Zone Frozen (MZF) temperature mode. On a machine using the MZF setting, the Upper Zone follows the HS rules for Cold Food and the Lower Zone follows the HS rules for Frozen Food.

IMPORTANT! The operator is responsible for ensuring the health safety of vended products and to verify the machine HS settings. Make sure to Enable All Items and Enable HS Zone Lower and/or Upper Zone before making any other changes.

4.9.3 HS “All”

STEP		DISPLAY
1.	Press Service Mode Button 	Motors (--)
2.	Press  for Configuration menu	Configuration
3.	Press  for Health Safety menu	Health Safety
4.	Press  to edit the Lower Zone or Press  to edit the Upper Zone	Lower Zone or Upper Zone
5.	Press  for All Items	All Items (Current) *- exit 3- edit
6.	Press  to toggle ON/OFF	All Items (Choice Flashing) *- exit # - save
7.	Press  to save the setting	All Items (New Setting) *- exit 3- edit
8.	Press  to exit All Items	Lower Zone or Upper Zone
9.	Press  to edit HS Zone ON/OFF	Enable (Current Setting) *- exit 9- edit
10.	Press  to toggle HS Zone ON/OFF	Enable (Choice Flashing) *- exit # - save
11.	Press  to save the setting	Enable (New Setting) *- exit 9- edit
12.	Press  to exit back to main HS menu	Health Safety
13.	Repeat steps 4 thru 12 for another Zone or go to step 14.	
14.	Press  five times to exit	(Sales Mode)

4.0 ADVANCED CONFIGURATION

NOTE: THIS IS PASSWORD PROTECTED (2314 DEFAULT)

4.0.1 BEEP ENABLE

See GVC 2 Programming Manual (P/N 4215507) for more information

4.0.2 OPTICS DISABLES

See GVC 2 Programming Manual (P/N 4215507) for more information

4.0.3 MOTOR TYPE

See GVC 2 Programming Manual (P/N 4215507) for more information

4.0.4 TALKER

See GVC 2 Programming Manual (P/N 4215507) for more information.







4.0.5 PASSWORD

See GVC2 Programming Manual (P/N 4215507) for more information.

4.0.6 SET DEFAULTS

See GVC2 Programming Manual (P/N 4215507) for more information.

4.0.7 REFRIGERATION CONFIGURATION SETTINGS

STEP		DISPLAY
1.	Press Service Mode Button 	Motors (- -)
2.	Press 	Configuration
3.	Press 	Password
4.	Enter Password (default 2314)	****
5.	Press  to edit Refrigeration Type. Default is Snack	FROZEN (Not used) Dual Zone (Not used) Dual Upper -6 (Not used) Chilled (Not used) MZF Multi-zone -10F & 36F MZF -2 Multi-zone -12F & 36F MZF -5 Multi-zone -15F & 36F SZ Frozen Single zone -10F SZ Frozen-2 Single zone -12F SZ Frozen-5 Single zone -15F SZ Cold Single zone 36F SZ Cold-1 Single zone 35F Snack (Not used) Cold (Not used) Slackened (Not used)
6.	Press  to save	MZF-5
7.	Press  4 times to exit	Sales Mode

4.0.9 OPEN DOOR MOTOR HOMING

With the Open Door Motor Homing feature set to ON every time the door of the machine is opened all motors not at the home position will be moved to the home position. This feature requires the machine to have a door switch assembly. To purchase a door switch assembly please contact Vendnet Parts by phone at 1-800-833-4411.

CAUTION: When motors are homed, product may be vended from tray location.

STEP		DISPLAY
1.	Press Service Mode Button 	Motors (--)
2.	Press 4 for Configuration menu	Configuration
3.	Press 0 for Password menu	Password
4.	Enter Password (default 2314)	Advanced Config
5.	Press 9 for Homing menu	Homing (Current Setting) *- exit 9- edit
6.	Press 9 to toggle between ON/OFF	Homing (Choice Flashing) *- exit # - save
7.	Press # to save new setting	Homing (New Setting) *- exit 9- edit
8.	Press * four times to exit	(Sales Mode)

4.0.0.2 AUTOMATED DELIVERY BOX

The function of the delivery lift is to lift the purchased product higher. This makes it easier for customer to get their product.

STEP		DISPLAY
1.	Press Service Mode Button 	Motors (- -)
2.	Press 4 for Configuration menu	Configuration
3.	Press 0 for Password menu	Password:
4.	Enter Password (default-2314)	Advanced Config
5.	Press 0 for Peripherals menu	Peripherals
6.	Press 2 for Auto Lift menu	Auto Lift (Current Setting) *-exit 2-edit
7.	Press 2 to toggle the setting. Choices are: <ul style="list-style-type: none"> • Button – requires customer to push the blue button to raise the lift after each vend • Auto – lift will raise after each vend • Off – turns the lift off 	Auto Lift (Choice Flashing) *-exit #-save
8.	Press # to save the setting	Auto Lift (New Setting) *-exit 2-edit
9.	Press * five times to exit	(Sales Mode)

4.0.0.3 TOUCH COMM

See GVC2 Programming Manual (P/N 4215507) for more information.

4.0.0.4 AUTO SERVICE

See GVC2 Programming Manual (P/N 4215507) for more information.

PRICING

Price Setting - This menu allows three (3) methods for assigning prices:

- ITEM — by individual selections
- ROW— by shelf or tray
- ALL ITEMS — by entire machine.
- COUPONS — by Item, Row, or ALL
- TOKENS — by Item, Row, or ALL
- COMBO

The maximum price that can be set is \$655.35.

5.1 ALL

This menu allows you to set the selection price of every item all at once.

Time Saving Tip:
Instead of setting the price of each item one at a time, it is much faster to set the common price of the entire machine; then go back and set the price of each item or row.

	STEP	DISPLAY
1.	Press Service Mode Button 	Motors (- -)
2.	Press 5	Pricing
3.	Press 3 to enter price	ALL Items \$0.50
4.	Press # to save.	ALL Itmes \$0.50
5.	Press * 3 times to exit.	(Sales Mode)

5.2 ROW

Use this menu to set the price of a row (shelf) all at the same time.

Time Saving Suggestion:
Instead of setting the price of one item at a time, set the common price of a Row, then go back and set the price of each item.

	STEP	DISPLAY
1.	Press Service Mode Button 	Motors (- -)
2.	Press 5	Pricing
3.	Press 2	Row: - - \$0.00
4.	Enter row number and price <i>Example: Top row=01, row below top row=02, etc. Program will automatically go to the next Row.</i>	Row:01 \$0.50
5.	Press # to save.	Row 01 \$0.50
6.	Press * 3 times to exit	(Sales Mode)

5.3 ITEM

This menu allows price setting by each selection item.

	STEP	DISPLAY
1.	Press Service Mode Button 	Motors (- -)
2.	Press 5	Pricing
3.	Press 1	Item
4.	Enter Item and price	Item 010 \$0.50
5.	Press # to save. The program will automatically go to the next selection number.	Item 010 \$0.50
6.	Press * 3 times to exit.	(Sales Mode)

5.4 COUPON OR TOKEN

Allows the operator to designate the values of coupons or tokens that are accepted by pre-programmed validators.

See GVC2 Programming Manual (P/N 4215507) for more information

5.7 COMBO

See GVC2 Programming Manual (P/N 4215507) for more information

6 ACCOUNTING

Use this menu to gain access to menus that display or reset data for various types of cash and vend totals. Counts can be viewed by individual items, rows or as the whole machine.



See GVC2 Programming Manual (P/N 4215507) for more information.

7 ADVANCED OPTIONS

See GVC2 Programming Manual (P/N 4215507) for more information.

8 TEST VEND – SINGLE MOTOR

Use this menu to test vend individual motors. The selection will display with the test vend. If a test vend attempt on a particular motor fails, controller will beep.



STEP		DISPLAY
1.	Press Service Mode Button 	Motors (- -)
2.	Press 	Item - - -
3.	Press selection number on keypad and wait	Item 010
4.	Repeat step 3 for other selections.	
5.	Press  3 times to exit.	(Sales Mode)

9 TEST ALL MOTORS

This menu will test vend all motors. The selection will display with the test vend. If a test vend attempt on a particular motor fails, then the controller will beep. Satellite machines will also be included in the test.

NOTE:





Pressing  at any time will stop the test.

STEP		DISPLAY
1.	Press Service Mode Button 	Motors (- -)
2.	Press  and wait.	Item
	The motor selection number will display while it is being tested.	Item 010
3.	Press  3 times to exit.	(Sales Mode)

0 DIAGNOSTICS

0.1 DIAGNOSTIC

This menu is used to perform a self-diagnostics check and display results.

STEP		DISPLAY
1.	Press Service Mode Button 	Motors (- -)
2.	Press 	Diagnostic...
	Press  to start test	Checksum Temp Sensor Optical Coin Acceptor Bill Validator Card Reader1 Card Reader2 Tests Completed
3.	Press  3 times to exit.	(Sales Mode)

0.2 TEST RELAY

Testing of Relays - This menu provides functions that allow the operator to test the operation of the individual relay lines 1 through 6.

See GVC2 Programming Manual (P/N 4215507) for more information.

0.3 LOG

Engineering download for service technician ONLY!

0.4 COIN REJECT RATE

This feature tracks the percentage of coins that have been rejected by the coin mech. This will be reset when in accounting "ALL" has been cleared.





0.5 BILL REJECT RATE

0.6 IVEND ALIGNED

0.7 ADVANCED DIAGNOSTICS

See GVC2 Programming Manual (P/N 4215507) for more information.

0.7.1 REFRIG LOG

STEP		DISPLAY
1.	Press Service Mode Button 	Motors (- -)
2.	Press 	Diagnostics
3.	Press 	Password:
4.	Enter Password (default-2314)	Log
5.	Press 	Refrig Log (Current Status) *- exit 1- edit
6.	Press  to toggle ON/OFF	Refrig Log (Choice Flashing) *- exit # - save

7.	Press # to save	Refrig Log (New Status) *- exit 1- edit
8.	Press * 4 times to exit.	(Sales Mode)

0.7.2 DAQ LOG

STEP		DISPLAY
1.	Press Service Mode Button 	Motors (- -)
2.	Press 0	Diagnostics
3.	Press 7	Password:
4.	Enter Password (default-2314)	Log
5.	Press 2	DAQ Log (after a few seconds, display changes to Log)
8.	Press * 3 times to exit.	(Sales Mode)

0.7.3 STS LOG







STEP		DISPLAY
1.	Press Service Mode Button 	Motors (- -)
2.	Press 0	Diagnostics
3.	Press 7	Password:
4.	Enter Password (default-2314)	Log
5.	Press 3	StS (after a few seconds, display changes to Log)
8.	Press * 3 times to exit.	(Sales Mode)

0.9 MANUAL DEFROST

STEP		DISPLAY
1.	Press Service Mode Button 	Motors (- -)
2.	Press 0	Diagnostics
3.	Press 9	Manual Defrost (Current Status) *- exit 9- edit
4.	Press 9 to toggle ON/OFF	Manual Defrost (Choice Flashing) *- exit # - save
5.	Press # to save	HS Test (New Status) *- exit 1- edit
6.	Press * 3 times to exit.	(Sales Mode)

0.0.2 AUTOMATED DOOR

Opens and closes the Delivery Lift box product door and indicates if the control board detects the motor cam switch to be in the correct position.







STEP		DISPLAY
1	Press the 'Service Mode'  button on the control board.	(Motor count)
2	Press 	Diagnostics
3	Press 	Peripherals
4	Press  to see current Auto Door position	Auto Door Closed 1-open 2-close * - exit
5	Press  - OPEN DOOR ,  -CLOSE DOOR	Auto Door Closed 1-open 2-close * - exit
6	Press  3 times to exit	Back to sales mode

NOTE: The display will show the current "Open" or "Closed" position while the Auto Door is moving to a new position. If the control board can't determine an Auto Door motor position, the "Unknown" message will also appear.

IMPORTANT: If the control board cannot determine the Auto Door position when the sales mode is entered or while in the sales mode, the machine will be placed **Out of Service**.

0.0.3 DELIVERY LIFT TEST

Raises and lowers the Delivery Lift plate and indicates if the control board detects the motor cam switch to have the Delivery Lift in the correct position.





STEP		DISPLAY
1	Press the 'Service Mode'  button on the control board.	(Motor count)
2	Press 	Diagnostics
3	Press 	Peripherals
4	Press 	Lift Down 1 – up 2 – down *-- exit
5	Press  - Raise the lift to top position ,  -Lower the lift to the bottom (Home) position	Lift Down 1-UP 2-DOWN * - exit
6	Press  3 times to exit	Back to sales mode

NOTE: The display will show “Lift Unknown” while the Delivery Lift is moving to the up or down position. If the control board can’t determine a Lift motors cam position the “Lift Unknown” message will also appear and stay present.

IMPORTANT: Do not attempt to run the Delivery Lift Test diagnostic if the Delivery Lift Plate may be jammed. Manually correct this issue before running test. Contact Vendnet Service at 1-800-833-4411 for assistance or more information.

0.0.6 LIFT OPTICS ALIGN

This indicates if the Delivery Lift Sensors are functioning and aligned so that they can detect when a product is lifted to the correct height. The Green LED on the lift optics board (located behind the iVend Red LED sensor board) will also be illuminated when sensors are aligned.

STEP		DISPLAY
1	Press the ‘Service Mode’  button on the control board.	(Motor count)
2	Press 	Diagnostics
3	Press 	Peripherals
4	Press  Shows current state of sensors. OK is unblocked and ready . NO is blocked or not operational. The time counter allows for determining how long a product or object is blocking the sensors.	Lift Optics Align OK or NO 0000 ms
5	Press  3 times to exit	Back to sales mode

TEMPERATURE CONTROL

To prevent damage to the refrigeration unit when it is turned off or the power is interrupted, the refrigeration unit will not restart for at least five minutes regardless of the temperature.

SENSORS

Temperature sensor(s) are positioned to best represent the product temperature. The sensor(s) are monitored by the controller program. The refrigeration and heater systems are activated depending on the target temperature setting or **SET POINT**. The total allowable temperature variation from the **SET POINT** is **DELTA**.

SENSOR 1 is located on right side towards the back between trays 4 and 5 and controls the bottom zone temperature of the multi-zone by switching the compressor on and off. Sensor 1 is not used if the machine is configured as a single zone.

SENSOR 2 is located on right side of the evaporator and mounted to the top tube with a copper clip and tie strap. Sensor 2 is used to measure evaporator temperature and terminates a defrost cycle when the coil reaches 50°F.

SENSOR 3 is located on right side towards the back between trays 1 and 2 and controls the upper zone temperature by switching the foil heater on and off when machine is configured as a multi-zone. If the machine is configured as a single-zone cold or frozen, Sensor 3 controls the entire cabinet temperature by switching the compressor on and off.

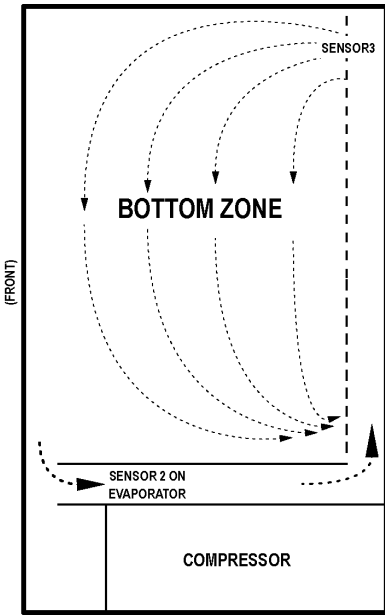

Figure 8a. Single Zone Airflow

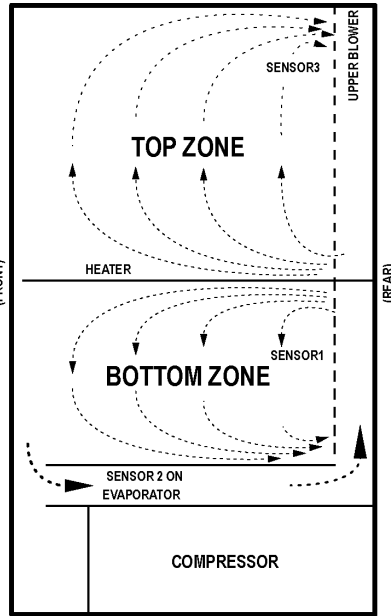

Figure 8b. Multi- Zone Airflow

RELAYS

The program controls four relays which then control the refrigeration and heating systems:

- **RELAY1** - controls the compressor and the condenser fan (refrigeration system).
- **RELAY2** - controls the upper zone blower / heater & evaporator fan via the door switch.
- **RELAY3** - controls the defrost heater and evaporator fan.
- **RELAY4** - controls the upper zone heater when configured as MZF

NOTE: For more information regarding the Power Panel, please refer to schematic.

DOOR SWITCH

The door switch is located in the upper left hand corner of the vending machine door. See Figure 8c.

- If the vending machine is plugged in and the power switch is on and the door is open, then the compressor, evaporator fan, heater and heater fan are all turned off. A 30 minute door timer starts and a compressor delay timer starts.
- If the door is open for more than 30 minutes, the controller will resume closed door operation, the message **DOOR OPEN** is displayed and error code (VMC 7) is set. The **DIAGNOSE** menu will also display the current state of the door switch after all other messages (if any) are displayed. **DOOR** is displayed if the door switch is in the "door open position" and no message is displayed if the door switch is in the "closed door position".

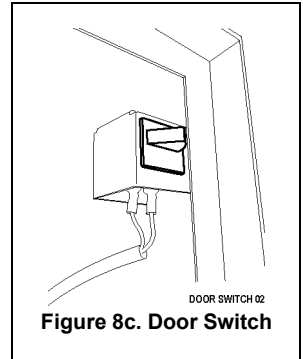

If a defrost cycle is in progress (compressor off and defrost **DURATION** timer on) and the door is opened, then the **DURATION** timer continues while the door is open.

The **HEALTH SAFETY** feature prevents the sale of perishable food if the air temperature inside the top zone (**SENSOR3**) rises above the health safety temperature limits for cold food products (41°F / 5°C) for more than 15 minutes and in the bottom zone (**SENSOR1**) if the temperature rises above the health safety temperature limits for frozen food products (0°F/-18°C) for more than 15 minutes.

NOTE: The time requirements for the COLD setting do not apply for 30 minutes and 75 minutes for FROZEN immediately following vending machine filling or servicing.

IMPORTANT! The operator is responsible for setting the health safety at the correct level and selection range for the product being vended.

Refer to the GVC2 Programming Manual (p/n 4215507) for additional instructions on how to set the **Sensor1&3 Health Safety Level** and **Sensor1&3 Health Safety Range**.

HEALTH SAFETY FIELD TEST

0.7.4 HEALTH SAFETY TEST

The **HEALTH SAFETY** feature prevents the sale of perishable food if the air temperature inside the Satellite Food Vendor compartment rises above the Health Safety temperature limit for more than 15 minutes. The factory default for health safety limit is automatically set when the refrigeration configuration is set. The perishable products being vended must match the refrigeration configuration.

Important Note: Make sure that the **Health Safety** setting is enabled prior to starting this test. See Service Mode 4.9.1 below.

1. Close the door and wait 75 minutes for the temperature stabilize
2. Simulate Warm Temperature
 - a. Open the door
 - b. Locate the sensor at the back of the cabinet above the top tray.
 - c. Remove the mounting screw; place the sensor in a cup of warm water.
 - d. Enable **HS Test software setting** in control board service mode. See below
 - e. Close the door.
3. Perform Test
 - a. Press **0** on the host machine numerical keypad to check the temperature.
 - b. Wait until the temperature is above the upper health safety limit of 41°F for 15 minutes.
 - c. Try to vend a product from the Satellite Food Vendor.
 - d. If the health safety is working properly the vend should fail; the machine should have automatically been disabled by the controller board.
4. After Test is Completed
 - a. Open the Satellite Food Vendor door
 - b. Remove the sensor from the cup of water and put the sensor back in place.
 - c. Close the door and time how long it takes for the Satellite Food Vendor to get below the refrigeration set point. . Cold should be below the set point within 30 minutes.

When HS test ON (HS Door switch override ON) is saved in Service mode, and the machine door is closed the Health Safety Activation Delay Time is set to the 15 minute value rather than the extended 30 minutes for Cold and 75 minutes for Frozen that is allowed after a normal door closure. To allow for multiple door open/closes and door close debounce the HS test mode is active for 3 minutes after "HS test ON" is set in Service Mode, so that if the door is opened/closed multiple times the 15 minute timer would be set again and still be used. Also, when "HS test ON" is set the refrigeration OFF timer should also be reset at this time so that when it is time for the minimum off time to expire the "HS test ON" mode is also cleared. Once the door is closed Health Safety feature now functions as if the machine door had been closed for a long period of time and any temperature value over the HS limit, for the refrigeration mode in use, causes the normal 15 minute HS limit timer to start a count and if the temperature limit is exceeded for 15 minutes disables vending from the machine. Refrigeration Modes affected are: Cold, Frozen and MZF

STEP		DISPLAY
1.	Press Service Mode Button 	Motors (- -)
2.	Press 0 for Diagnostics menu	Diagnostics
3.	Press 7 for Password menu	Password:
4.	Enter Password (default-2314)	Log
5.	Press 4 for Health Safety test	HS Test (Current Setting) *- exit 4- edit
6.	Press 4 to toggle ON/OFF	HS Test (Choice Flashing) *- exit # - save
7.	Press # to save the setting	HS Test (New Setting) *- exit 4- edit
8.	Press * four times to exit	(Sales Mode)
Press 0 in Sales Mode to see current temperatures and "HS Test" message		

REFRIGERATION

To prevent damage to the refrigeration unit when it is turned off or the power is interrupted, the refrigeration unit will not restart for at least five minutes regardless of the temperature.

REFRIGERATION TROUBLESHOOTING

CAUTION: Breaking the refrigerant joints or seals on the system voids the unit warranty. Failure to keep the condenser coil clean and free of dirt and dust and other similar debris voids the unit warranty.

Know and understand how the unit operates. Units may vary, but the operation is basically the same. Never guess at the problem; find the symptom before attempting any repair.

NOTE: Most refrigeration problems are electrical.

WARNING: Wiring diagrams must be followed as shown. Wrong wiring may cause serious electrical hazard and potential damage or rupture component electrical parts.

Table 1. Approximate Winding Resistance

Across Terminals	Error! Reference source not found.	
COMMON to START:	2.9 Ohms	
COMMON to RUN:	0.9 Ohms	
COMMON to SHELL:	No continuity	

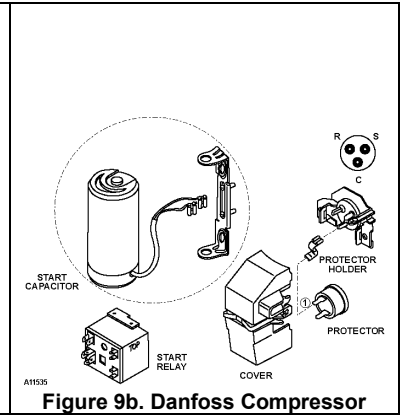
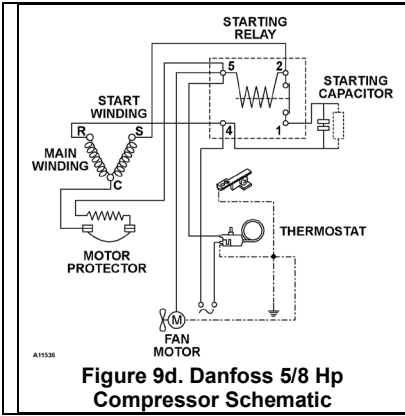

The sealed hermetic system should not be worked on outside the Factory Service Center. There are three things that can go wrong with a sealed system and should be repaired only at the Factory Service Center. These are:

1. **Low Charge** - usually caused by leaks; look for oil around seals and welds. Unit will not cool properly.
2. **Restriction in Systems** (unit frosts, then melts) - not cooling properly.
3. **Bad valves** - unit does not cool properly-- noisy compressor.

COMPRESSOR WILL NOT START

Compressor has no power:

- Vending machine not plugged in.
- Tripped circuit breaker or blown fuse.
- Faulty wall outlet or improper wiring.
- Faulty (short or open) power cord.
- Temperature sensor circuit is open. If temperature reading of **SENSOR1** is “- - °F”, then check sensor harness connection or defective sensor.
- Low voltage. Check the power source with a volt meter. Minimum 103V for 115VAC, 60Hz. Minimum 195V for 230VAC, 50 Hz.
- Check motor protector (overload). See page 33, Troubleshooting Circuits with Multi-Meter.
- No DC voltage. Check control board terminals J14-8, J14-14 for a loose connection.
- Check compressor starting relay. See page 33, Troubleshooting Circuits with Multi-Meter.
- Check compressor winding. See page 33, Troubleshooting Circuits with Multi-Meter.
- Defective refrigeration control relay. Switch the controller to **Service Mode** then verify that the relay turns on by using the **TEST RELAY** menu.
- Unplug power to the vending machine. Open the power panel. Use insulated jumper wires to short the wire terminals on **RELAY1**; between 2 and 4. Restore power to the vending machine. The compressor should start, indicating a problem in the control circuit.
- Check relay terminals 1 to 0 with a Multi-Meter. Should have 24VDC applied to them.
- Check the door switch operation. See Door Switch section on page 27.

COMPRESSOR TRIPS ON OVERLOAD

1. Improper voltage: Check power source with volt meter. Acceptable range is 103-127VAC for 115V (60Hz), or 195-255VAC 230V (50Hz).
2. Defective starting relay. Won't open after starting. Check compressor starting relay. See page 33, Troubleshooting Circuits with Multi-Meter.
3. Compressor has shorted windings. Check compressor winding resistance values. See page 33, Troubleshooting Circuits with Multi-Meter.
4. Short in other component: Isolate and eliminate each electrical component until short is found.
5. Compressor is too hot.
 - ◆ Dirty condenser.
 - ◆ Faulty condenser motor or blade.
 - ◆ Restricted airflow. Check for clogged air filter. Check for clogged inlet and outlet screens.
6. Defective or worn out overload: Trips too fast or too often.

CAUTION: Replace air filter every 3 months to maintain proper air circulation to the condenser and to prevent dirt and debris from clogging up the condenser.

NOISY OR VIBRATING UNIT

1. Components rubbing or touching each other.
 - ◆ Check fan blades and motor.
 - ◆ Loose shrouds and harness.
 - ◆ Copper tubing.
 - ◆ Loose or unsecured parts.
 - ◆ Dirty condenser fan blades.
2. Worn or aged compressor grommets.
3. Compressor.
 - ◆ Bad valves.
 - ◆ Slugging.
 - ◆ Bad windings (Refer to Table 1 and schematic on page 29.).
 - ◆ Voltage too low.

UNIT SHORT CYCLES

- Defective condenser fan.
 - Dirty or blocked condenser coils.
 - Dirty or blocked air filter.
 - Dirty or blocked inlet or outlet screens.
 - Defective overload (motor protector).
- Temperature sensor is defective or not mounted in the correct spot.
 - Temperature setting set too warm. See Temperature Control section and Factory Default Settings section of this manual.
 - Defective control board.

UNIT OPERATES LONG OR CONTINUOUSLY

1. Airflow restricted.
 - ◆ Clogged or blocked inlet screen, air filter, or outlet screen.
 - ◆ Exhaust area blocked. Vending machine too close to wall.
 - ◆ Airflow blocked by product in front of evaporator or air duct openings.
 - ◆ Faulty evaporator motor or blades causing coils to ice.
 - ◆ Loose connections on evaporator motor. Motor not running.
2. Refrigeration relay shorted. Switch the controller to **Service Mode**, and then verify that relay turns off by using the **TEST RELAY** menu.
3. Gasket leak around main door or delivery door.
4. Excessive load: After loading, unit runs longer to pull out excessive heat from product.
5. Shortage of refrigerant or restriction.
6. Faulty controller.
7. Ambient air temperature and relative humidity exceed manufacturer's operational standards.
8. Defective temperature sensor or sensor has been moved or remounted to wrong spot.

REFRIGERATED SPACE TOO COLD

1. Refrigeration relay bad. Switch the controller to **Service Mode**, and then verify that relay turns on by using the **TEST RELAY** menu. Check relay terminals for continuity with an ohmmeter.
2. Faulty controller.

REFRIGERATED SPACE TOO WARM

- ◆ Condenser airflow restricted.
- ◆ Plugged or dirty condenser.
- ◆ Condenser motor or blades bad.
- ◆ Blade stuck.
- ◆ Condensing space restricted.
- ◆ Unit placed too close to a wall.
- ◆ Compressor - bad valves.

TROUBLESHOOTING CIRCUITS WITH MULTI-METER

Caution: Power must be disconnected and fan circuit open.

1. To check the power source, use the voltage section of the Multi-Meter. Acceptable range is 103-127VAC for 115V (60Hz), or 195-255VAC 230V (50Hz).

Danfoss 5/8 HP – Remove relay from compressor. See Figure 9b and Figure 9d on pages 30 and 30.

- Use ohmmeter to check for continuity between switch terminals 1 and 2. Replace if continuity exists.
- Use ohmmeter to check for continuity between coil terminals 5 and 2.

2. **Check temperature sensor harness** to control board for continuity using ohmmeter of Multi-Meter. Replace if there is no continuity.

3. **Check compressor windings** using ohmmeter. Refer to Table 1, Figure 9b, and Figure 9d on page 30.

4. **Check motor protector (overload).** Use the ohmmeter section of the Multi-Meter.

Danfoss 5/8 HP – Remove the overload. Check between the overload terminals for continuity. If no continuity is measured (infinity), overload may be tripped. Wait 10 minutes and try again. If still no continuity, overload is defective.

REMOVING THE REFRIGERATION SYSTEM

CAUTION: Always disconnect power source BEFORE servicing.

1. Turn off Main Power Switch and unplug vendor power cord from wall outlet.
2. Remove the bottom tray but not rails.
3. Locate the cabinet control harness and temperature sensor harness on the top right of the refrigeration unit. Unplug the connector to refrigeration unit, the temperature sensor 2, and the evaporator fan. See Figure 9g. Remove harness from any retaining clips mounted on the refrigeration unit.
4. Remove the two (2) screws on the front spacer bracket. Pull on the top edge of the front spacer bracket and swing it down to remove it.
5. Remove the front retaining bracket by removing the four (4) screws. See Figure 9h.
6. Remove the mounting screw securing the metal wedge from the left side of the refrigeration unit. Pry and remove the metal wedge.
7. Pull the refrigeration unit halfway out of the cabinet. Unplug the condenser fan harness from the back of the refrigeration unit. Pull the refrigeration unit out.

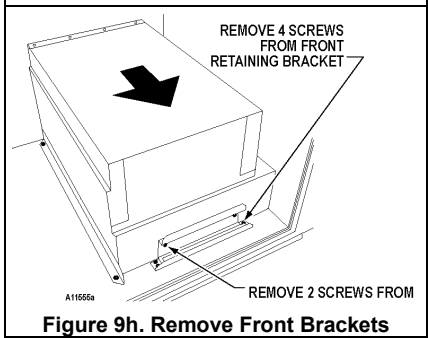
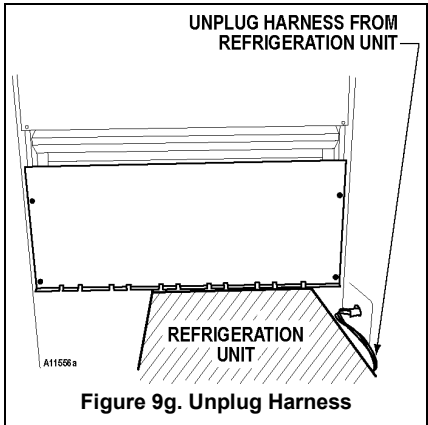

NOTE: All gaskets must seal tightly to the back and right side of the cabinet when installing the refrigeration unit back into the cabinet.

PREVENTIVE MAINTENANCE

CAUTION: Always disconnect power source BEFORE cleaning or servicing.

ONCE A MONTH CLEAN CABINET INTERIOR

Wash with a mild detergent and water, rinse and dry thoroughly. Odors may be eliminated by including baking soda or ammonia in the cleaning solution. Plastic parts may be cleaned with a quality plastic cleaner.

The vend mechanisms must be kept clean. Any build-up can cause the mechanisms to malfunction.

Do not get the cleaning solution on electrical components.

To insure proper vending keep delivery box area free of dirt and sticky substances.

CLEAN CABINET EXTERIOR

Wash with a mild detergent and water, rinse and dry thoroughly. Clean occasionally with a quality car wax. Plastic exterior parts may be cleaned with a quality plastic cleaner.

CONVERTING FROM SINGLE ZONE TO MULTI-ZONE MODE

(REQUIRED: Optional Multi-Zone Conversion Kit)

1. Turn power switch off.
2. Remove top four trays from machine by unplugging tray harness and pulling trays out of tray rails.
3. Install turning vane with air holes in bottom opening
4. Move existing turning vane located at top of machine to center opening and install along with the second turning vane provided in kit
5. Install upper blower fan and plug into existing harness(Fig. 10)
6. Install upper zone temperature sensor
7. Assemble and install insulating barrier, locate existing harness in air duct and connect to upper zone foil heater
8. Install air curtain on bottom side of tray four
9. Replace trays to proper locations, it is critical that the curtain is installed properly on the fourth tray down to insure proper airflow.
10. Turn power switch on and reconfigure control board to multi-zone mode. (See Configuration Instructions)

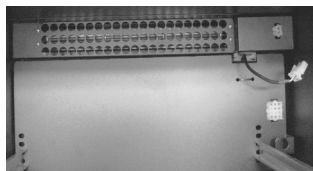

Figure 10 – Upper blower fan

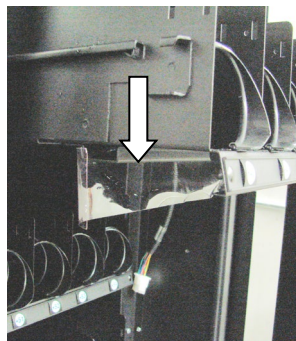

Figure 11 – Air Curtain

CONVERTING FROM MULTI-ZONE MODE TO SINGLE ZONE

1. Turn power switch off
2. Remove top four trays from machine by unplugging tray harnesses and pulling trays out of Tray Rails
3. Remove insulating barrier by removing screws
4. located on each side underneath front edge and unplugging foil heater.
5. Unplug harness and remove upper zone blower fan (Fig. 10)
6. Remove turning vane with air holes from bottom opening
7. Remove one of two existing Turning Vanes (see Fig.12) located in center opening

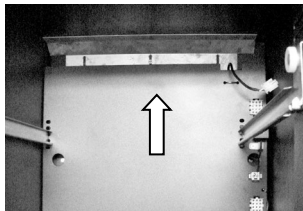

Figure 12: Turning Vane

- and move second turning vane to top
8. Remove air curtain from bottom side of tray four (Fig. 11)
 9. Replace trays to proper locations and connect harnesses
 10. Turn power switch on and reconfigure control board to either single zone cold food or single zone frozen mode (See Configuration Instructions).

Every 3 Months

REPLACE AIR FILTER

The refrigeration air filter is to prevent dust from building up on the condenser coils and allows the refrigeration system to operate efficiently.

- Pull the filter and check the air filter.
- If filter is dirty, replace it with the same size and type filter.
- Airflow arrow on filter must point to the left (towards the inside of vending machine).

WARNING: Do not replace with a HEPA type filter. This type may not allow the correct amount of air to flow through.

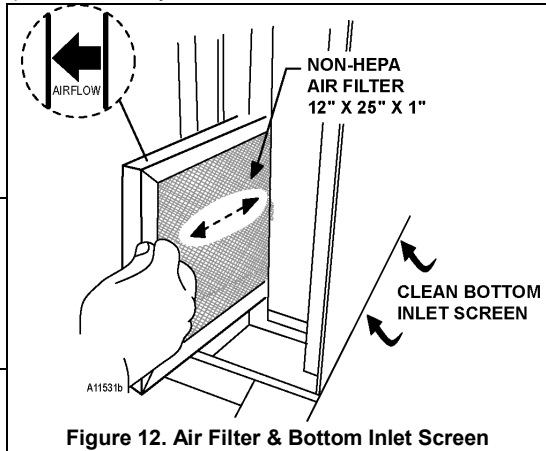

CLEAN BOTTOM INLET SCREEN

The inlet screen is a long narrow screen located on the bottom right side. It can only be accessed from underneath the cabinet. See Figure 12 on page 36. Remove dust and debris from the inlet screen to allow air to flow to the condenser coils.

EVERY 6-MONTHS

CLEAN DOOR AND DELIVERY DOOR SEALS

Clean the door seals. Inspect them for any deformities or cracking.

CLEAN EVAPORATOR COIL

Open the door. Clean the evaporator coil of refrigeration unit using a soft bristle brush and/or vacuum cleaner.

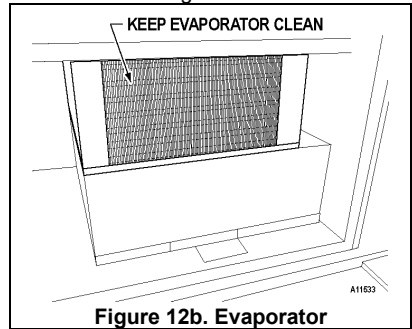

Figure 12b. Evaporator

CLEAN REAR SCREEN

Remove the **Back Screen Cover** from cabinet back. Clean dust and debris from screen using a soft bristle brush or a vacuum cleaner.

NOTE: Remove screws from Back Screen Cover at the back of the machine, 3 from top and 2 from bottom. Fig. 12c.

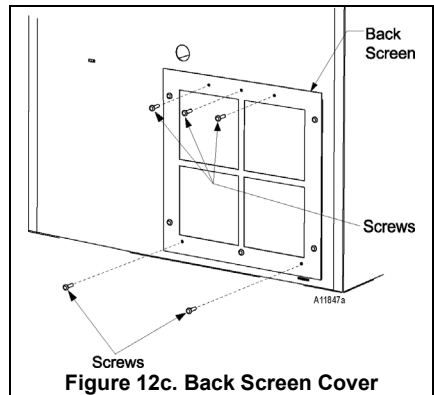

Figure 12c. Back Screen Cover

CLEAN DELIVERY BOX BOTTOM

Inspect the Delivery Box. Wipe clean any dirt and debris that may have accumulated.

The bottom half of the Delivery Box can be removed for thorough cleaning. To remove the Delivery Box Bottom, loosen the three (3) thumbnuts located on the rear of the Delivery Box. Lift up then pull it out.

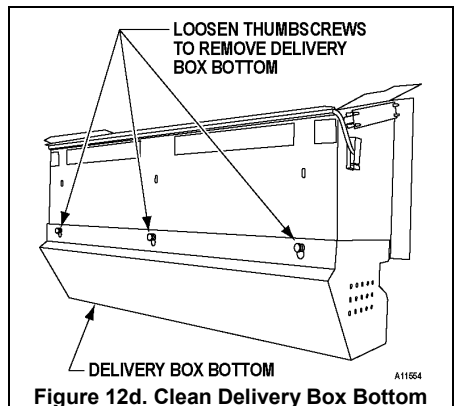

Figure 12d. Clean Delivery Box Bottom

PARTS ORDERING PROCEDURE

When ordering parts, include the following:

1. The model and serial numbers of the vending machine for which the parts are needed.
2. Shipping address.
3. Address where the invoice should be sent.
4. The number of parts required.
5. Always refer to the pertinent parts and/or part manual for the correct part number and description of a specific part.

NOTE: When RIGHT or LEFT is used with the name of a part, it means the person is facing the vending machine with the door closed.

6. Any special shipping instructions.
7. Carrier desired: air or air special, truck, parcel post or rail.
8. Signature and date.
9. Purchase order number, if used.

All orders are carefully packed and inspected prior to shipment. Damage incurred during shipment should be reported at once and a claim filed with the terminating carrier.

If you do not have the right parts manual: contact VendNet™.

If you have any questions, check out our Website www.vendnetusa.com or call VendNet™. Ask for the Parts Department. We will be happy to assist you. Email: vendnet@vendnetusa.com

BEFORE CALLING FOR SERVICE

Please check the following:

- Does your vending machine have at least 6-inches of clear air space behind it?
- If the power is turned on at the fuse box, is the vending machine the only thing that doesn't work?
- Is the vending machine plugged directly into the outlet?

WARNING: Extension cords can cause problems. DO NOT USE EXTENSION CORDS.

- Is the evaporator coil free of dust and dirt?
- Is the condenser coil free of dust and dirt?
- Is the compressor free of dust? A blanket of dust can prevent the compressor from cooling in between workout cycles.
- Is the circuit breaker at the fuse box reset?
- Is the evaporator fan working? To check if the fan is running take a small piece of paper in front of the evaporator coil and see if the evaporator fan will draw the paper. See Figure 12b on page 37.
- Is the condenser fan running? Fold a sheet of 8 1/2" x 11" paper in half. Place the paper in front of the condenser coil inlet screen located on the bottom right side underneath the cabinet and see if it draws the paper to it. See Figure 1 on page 36.
- Is the shelf in front of the evaporator coil clear? (No tools, product, or other air-restricting items)

NOTES

The contents of this publication are presented for informational purposes only, and while every effort has been made to ensure their accuracy, they are not to be construed as warranties or guarantees, express or implied, regarding the products or services described herein or their use or applicability. We reserve the right to modify or improve the designs or specifications of such products at any time without notice.



VendNet™
8040 University Blvd
Des Moines, IA 50325
United States of America



	USA & Canada	International
Service	(800) 833-4411	(515) 274-3641
Parts	(888) 259-9965	
Email	vendnet@vendnetusa.com	
Web Site	www.vendnetusa.com	